

Button 'FEED' Instruction

■ Button 'FEED' Instruction

Scene mode	Key operation	Corresponding function
Power on	Long press + boot	Print out the self test page
Standby	Press 3 seconds	Enter into the learn mode of cover sheet
Open the cover	Press 10 seconds	Factory reset
Standby	press	Feedin a blank paper automatically
Continuous printing	press	Print pause
Print pause	press	Resume printing

© All illustrations in this guide may differ from the actual ones, kind prevail.

Warranty Card

Warranty Instruction

Dear User:

Thank you for choosing our printer products, we provide efficient and high-quality warranty services for the products, please read the following terms carefully and pay attention to the relevant matters.

1. The user with the warranty card and purchase documents can enjoy the whole printer warranty service for one year from the date of purchase. During the warranty period, spare parts damage or printer error caused by quality problems can be replaced or repaired free of charge.

2. During the warranty period, if there are the following circumstances, you may not enjoy the warranty service:

- A. Damage or error caused by improper use of the user;
 - B. Damage or error caused by disassembly or maintenance by unauthorized companies or users;
 - C. Damage or error due to force majeure;
 - D. No warranty or purchase documents, purchase documents and products do not match or alter
3. Appropriate charges shall be charged for replacement or repair after the warranty period and for damage or error caused by the contents of Article 2 of this warranty instruction.

Warranty Card			
Product Model		Date of Manufacture	Year Month
Name		TEL	
Address			
Distributor Name		TEL	
Machine Error			

Desktop Barcode Printer

Quick Installation Guide

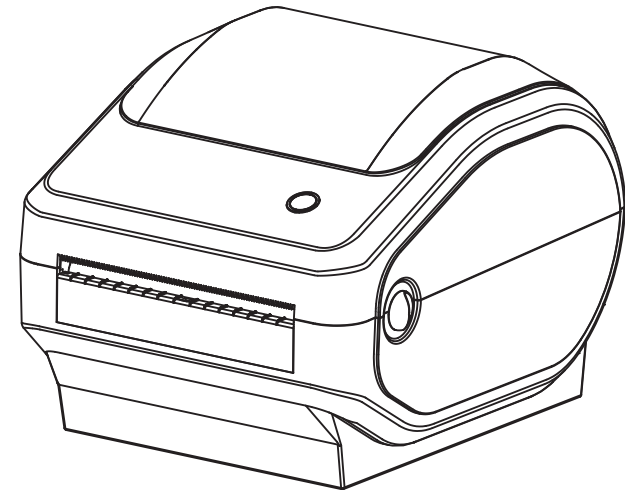

Download the driver&software from the website below:

<https://label.ggimage.com>

Opening-box List

Standard Accessories

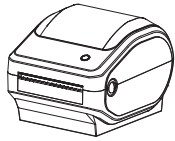

Printer

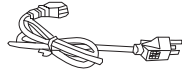

Power Cord

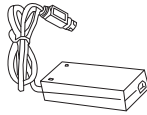

Adapter



USB Line



Quick installation guide

Cable Connection

Connect the power cable

1. Make sure the printer power switch is off;
2. Connect the adapter to the printer;
3. Connect the power cord to the adapter;
4. Connect the other end of the power cord to a nearby socket.

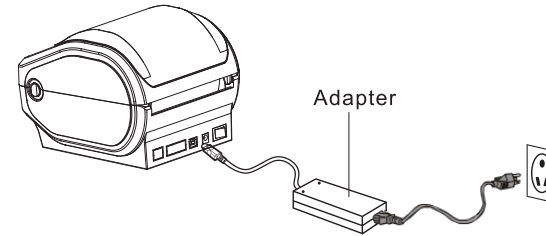

USB Connection

1. Connect USB to the printer;
2. Connect USB to the PC mainframe;
3. Turn on the printer power to be Power -on "—".

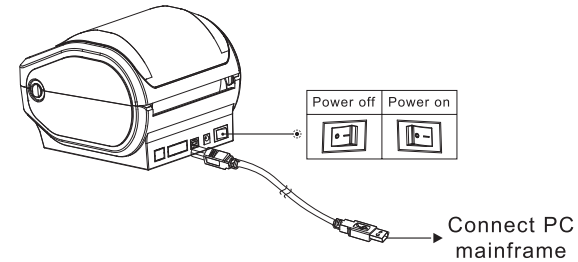

Appearance and Components

Front View

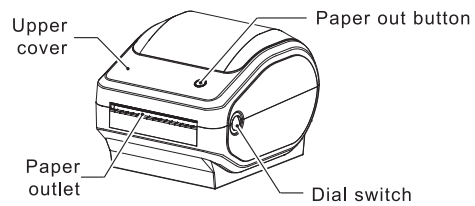

Rear View

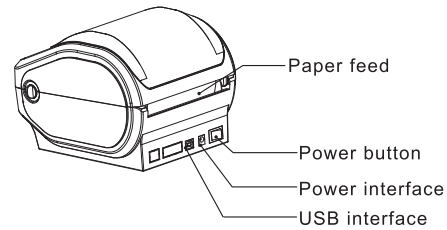

Inner View

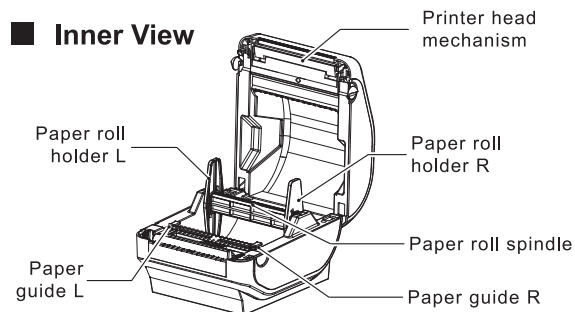

Consumables Installation

Inside-scroll Installation

1. Open fixing seat, put in paper roll with printed face above.

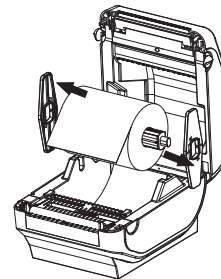

3. Close printer cover, press down to hear "ka" to lock.

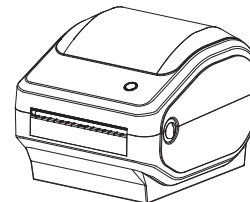

2. Make paper front through paper guide, pull paper exceed rubber roller, adjust paper guide to fix the paper according to the paper width.

